

L形エプロンブロックA

基本

参考重量501kg

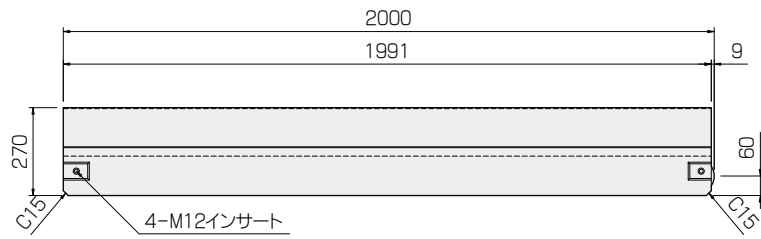
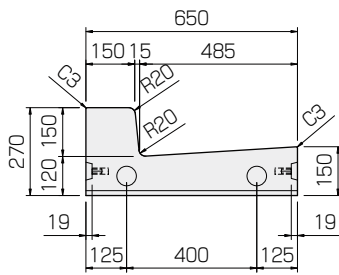

斜左(右)

参考重量238kg

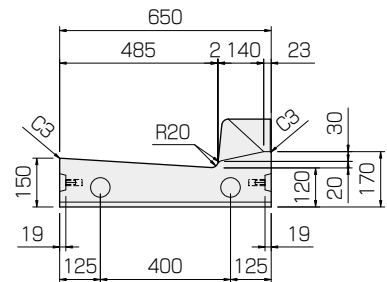
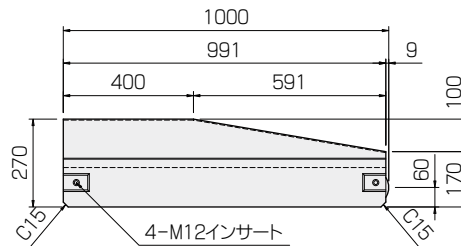
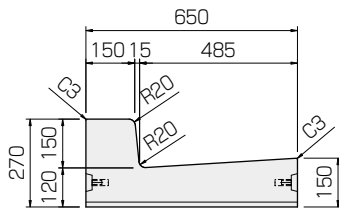

低

参考重量419kg

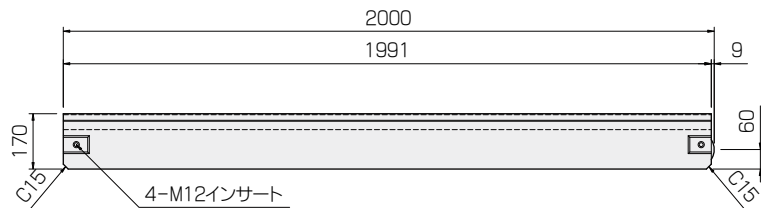
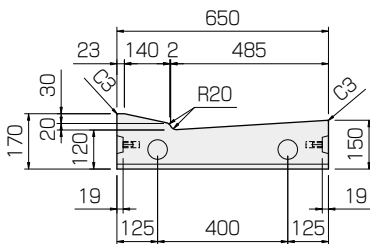

L形街渠樹

参考重量481kg

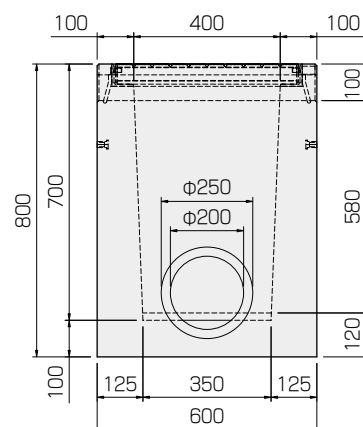
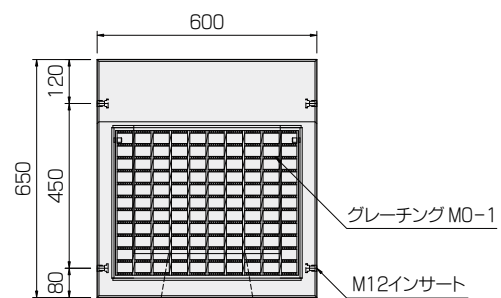
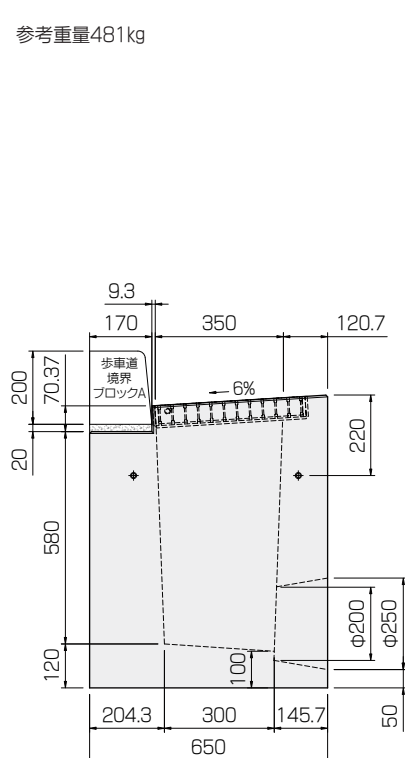

L形エプロンブロックA 防草タイプ

基本

参考重量589kg

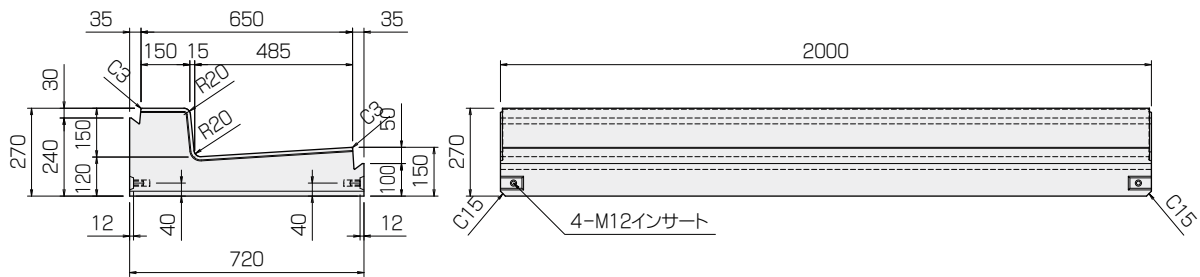

斜左(右)

参考重量279kg

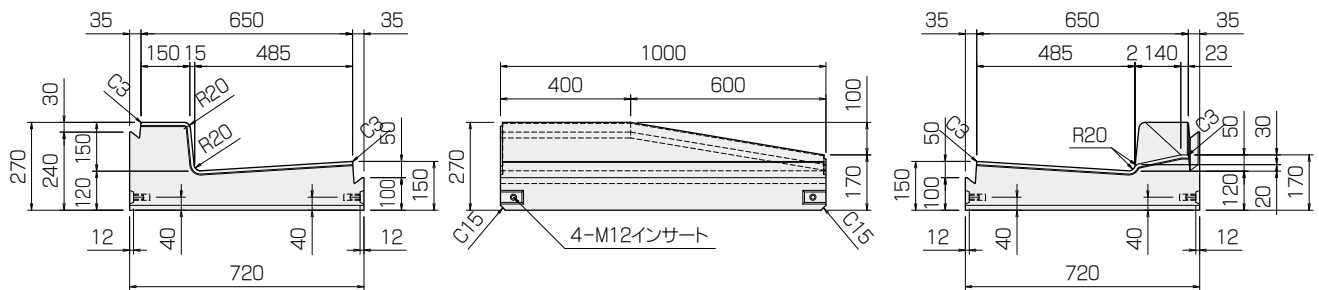

低

参考重量486kg

